

**INHALTSÜBERSICHT** *CONTENT OVERVIEW*



Bodenelemente **1**  
*Floor Elements*

Scharniere **2**  
*Hinges*

Nutmuttern und -schrauben **3**  
*T-Nuts and T-Bolts*

Verbindungstechnik **4**  
*Connecting Systems*

Griffe und Verschlüsse **5**  
*Handles and Latches*

Arbeitsplatzkomponenten **6**  
*Components for Work Stations*

Gleiter und Rollen **7**  
*Sliders and Rollers*

Fördertechnik **8**  
*Conveyors*

Schutz- und Trennwandelemente **9**  
*Enclosures, Guards, Partitions*



























Flächenbefestigungen **10**  
*Panel Fasteners*

**Abdeckelemente** **11**  
*Cover Elements*

Kabelführungen **12**  
*Cable Management*

Diverse Komponenten **13**  
*Miscellaneous Components*

Rundrohrkomponenten **14**  
*Tubular Frame Components*

	Abdeck- und Einfassprofil	<i>Cover and Reduction Profile</i>	719		Abdeckkappen für Schutzgitterprofile	<i>Cover Caps for Wire Mesh Frame Profiles</i>	738
	Abdeck- und Einfassprofil	<i>Cover and Reduction Profile</i>	720		Abdeckkappen anschraubbar	<i>Cover Caps Screw-on Type</i>	739
	Abdeck- und Einfassprofil	<i>Cover and Reduction Profile</i>	721		Abdeckkappen ZN anschraubbar	<i>Cover Caps ZN Screw-on Type</i>	740
	Abdeckprofil	<i>Cover Profile</i>	722		Kanal-Abdeckkappen	<i>Conduit Caps</i>	741
	Abdeck- und Einfassprofil	<i>Cover and Reduction Profile</i>	723		Abdeckkappe für Einhängprofil	<i>Cover Cap for Suspension Profile</i>	742
	Abdeck- und Einfassprofil	<i>Cover and Reduction Profile</i>	724		Abdeckkappen	<i>Cover Caps</i>	743
	Abdeckprofil	<i>Cover Profile</i>	725		Clip 8	<i>Clip 8</i>	744
	Abdeckprofil	<i>Cover Profile</i>	726				
	Abdeckprofil	<i>Cover Profile</i>	727				
	Abdeckprofil	<i>Cover Profile</i>	728				
	Abdeckprofil	<i>Cover Profile</i>	729				
	Abdeckprofil	<i>Cover Profile</i>	730				
	Abdeckkappe für Rastermaß 20 mm	<i>Cover Cap for 20 mm Modular Dimension</i>	731				
	Abdeckkappe für Rastermaß 30 mm	<i>Cover Cap for 30 mm Modular Dimension</i>	732				
	Abdeckkappe für Rastermaß 40 mm	<i>Cover Cap for 40 mm Modular Dimension</i>	733				
	Abdeckkappe für Rastermaß 45 mm	<i>Cover Cap for 45 mm Modular Dimension</i>	734				
	Abdeckkappe für Klemmprofil	<i>Cover Cap for Clamp Profile</i>	735				
	Abdeckkappe für Rastermaß 60 mm	<i>Cover Cap for 60 mm Modular Dimension</i>	736				
	Abdeckkappe für Klemmprofil	<i>Cover Cap for Clamp Profile</i>	737				



**ABDECK- UND EINFASSPROFIL**

**COVER AND REDUCTION PROFILE**

<b>Ausführung</b>	Kunststoff PP, Nut 5	<b>Model</b>	Plastic PP, slot 5
<b>Beschreibung</b>	zum Abdecken von Nuten mit Breite 5 mm und zum Einfassen von Flächenelementen mit 2 - 3 mm	<b>Description</b>	To cover size 5 profile slots and to secure panels with a thickness of 2 - 3 mm
<b>Material</b>	Kunststoff PP	<b>Material</b>	Plastic PP
<b>Farbe</b>	schwarz / natur	<b>Color</b>	Black / natural
<b>Liefereinheit</b>	200 Meter (100 Stück à 2 m)	<b>Pack Quantity</b>	200 meters (100 pieces at 2 m)
<b>Extras</b>	weitere Farben auf Anfrage	<b>Specials</b>	Other colors on request
<b>Hinweis</b>	Bitte beachten: Sie bestellen in Meter!	<b>Tip</b>	Please note: You are ordering in meters!

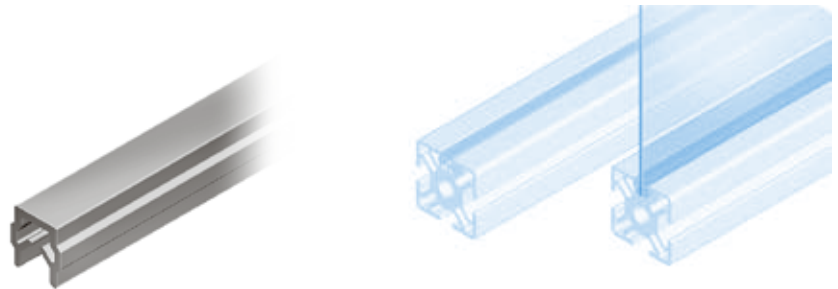
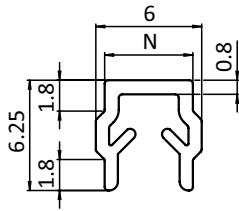

Abdeck- und Einfassprofil <i>Cover and Reduction Profile</i>	Nut <i>Slot</i>	Gewicht [g/m] <i>Weight [g/m]</i>	Profil <i>Profile</i>	Teil-Nr. <i>Part #</i>
schwarz <i>Black</i>	5	26.0	I	092045
natur <i>Natural</i>	5	26.0	I	092047

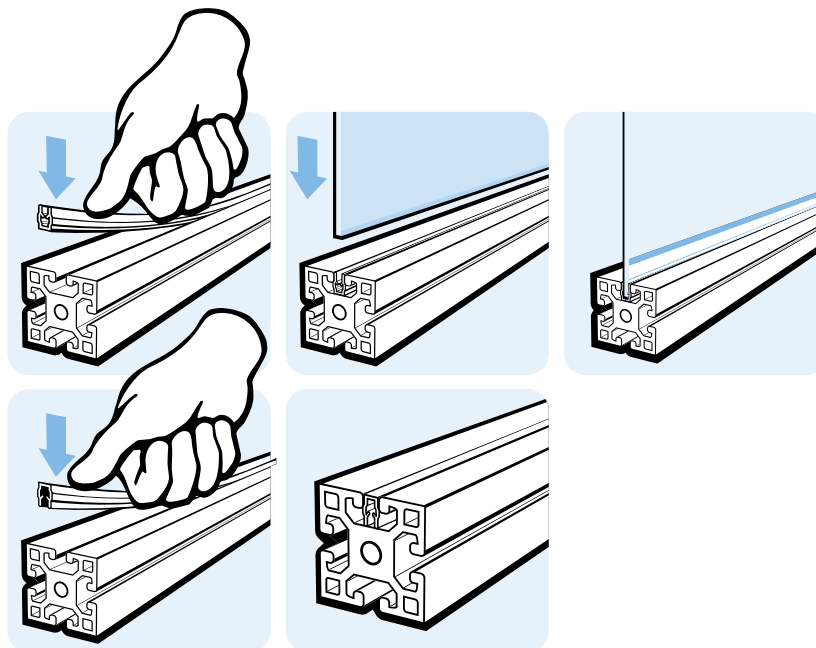



**ABDECK- UND EINFASSPROFIL**

**COVER AND REDUCTION PROFILE**

<b>Ausführung</b>	Kunststoff PP, Nut 6	<b>Model</b>	Plastic PP, slot 6
<b>Beschreibung</b>	zum Abdecken von Nuten mit Breite 6 mm und zum Einfassen von Flächenelementen mit 1 - 4 mm	<b>Description</b>	To cover size 6 profile slots and to secure panels with a thickness of 1 - 4 mm
<b>Material</b>	Kunststoff PP	<b>Material</b>	Plastic PP
<b>Farbe</b>	schwarz	<b>Color</b>	Black
<b>Liefereinheit</b>	200 Meter (100 Stück à 2 m)	<b>Pack Quantity</b>	200 meters (100 pieces at 2 m)
<b>Extras</b>	weitere Farben auf Anfrage	<b>Specials</b>	Other colors on request
<b>Hinweis</b>	Bitte beachten: Sie bestellen in Meter!	<b>Tip</b>	Please note: You are ordering in meters!

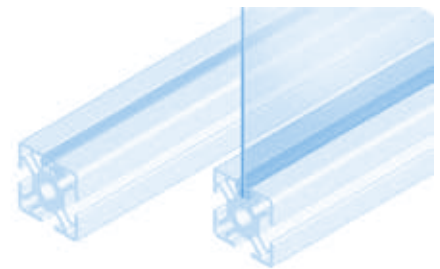
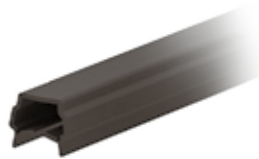
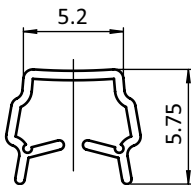

Abdeckprofil <i>Cover Profile</i>	Nut <i>Slot</i>	Gewicht [g/m] <i>Weight [g/m]</i>	Profil <i>Profile</i>	Teil-Nr. <i>Part #</i>
	6	17.0	B	092246

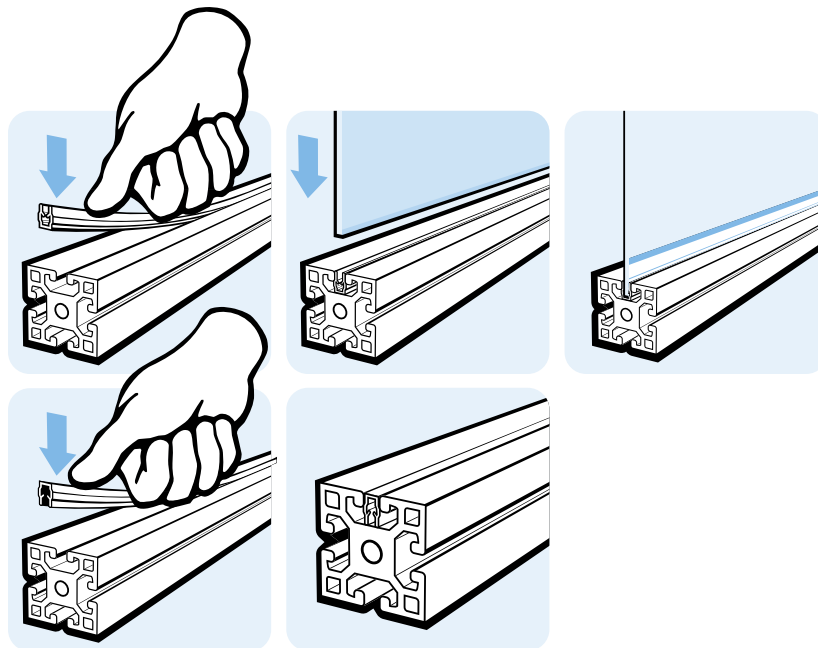



**ABDECK- UND EINFASSPROFIL**

**COVER AND REDUCTION PROFILE**

<b>Ausführung</b>	Kunststoff PP, Nut 6	<b>Model</b>	Plastic PP, slot 6
<b>Beschreibung</b>	zum Abdecken von Nuten mit Breite 6 mm und zum Einfassen von Flächenelementen mit 2 - 3,5 mm	<b>Description</b>	To cover size 6 profile slots and to secure panels with a thickness of 2 - 3.5 mm
<b>Material</b>	Kunststoff PP	<b>Material</b>	Plastic PP
<b>Farbe</b>	schwarz / natur / grau	<b>Color</b>	Black / natural / gray
<b>Liefereinheit</b>	200 Meter (100 Stück à 2 m)	<b>Pack Quantity</b>	200 meters (100 pieces at 2 m)
<b>Extras</b>	weitere Farben auf Anfrage	<b>Specials</b>	Other colors on request
<b>Hinweis</b>	Bitte beachten: Sie bestellen in Meter!	<b>Tip</b>	Please note: You are ordering in meters!

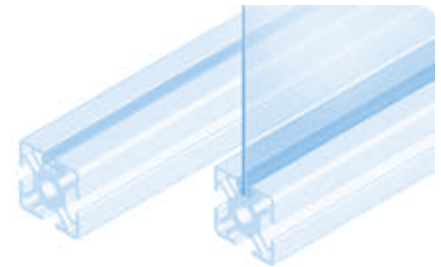
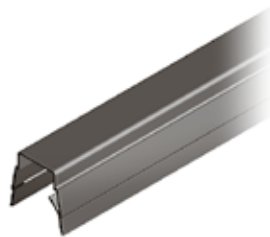
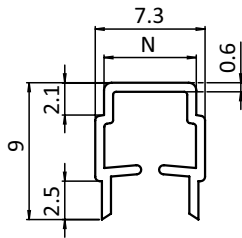

Abdeck- und Einfassprofil <i>Cover and Reduction Profile</i>	Nut Slot	Gewicht [g/m] Weight [g/m]	Profil Profile	Teil-Nr. Part #
schwarz <i>Black</i>	6	26.0	I	092033
natur <i>Natural</i>	6	26.0	I	092034
grau ≈ RAL 7035 <i>Gray</i>	6	26.0	I	092033S01

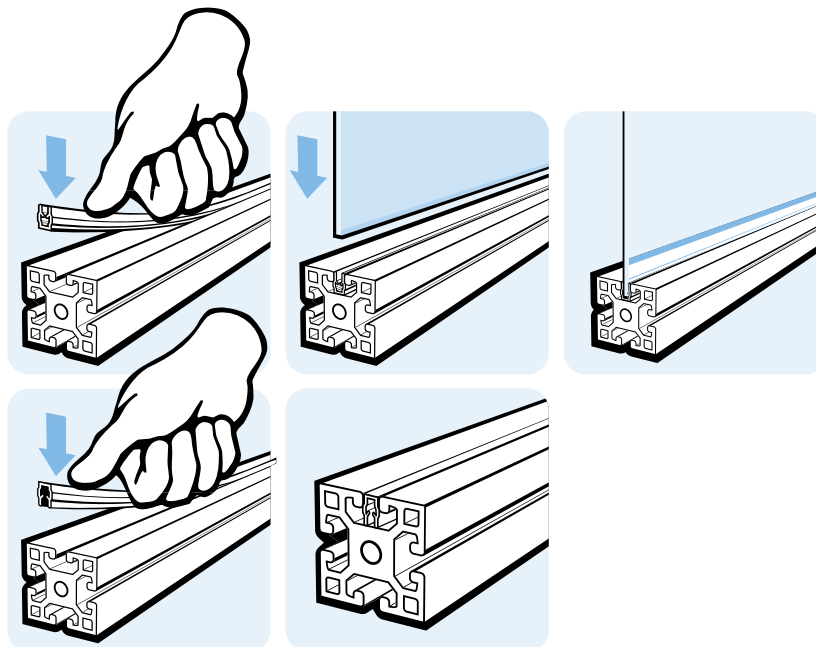



**ABDECKPROFIL**

**COVER PROFILE**

<b>Ausführung</b>	Kunststoff PP, Nut 6	<b>Model</b>	Plastic PP, slot 6
<b>Beschreibung</b>	zum Abdecken von Nuten mit Breite 6 mm und Steghöhe 3,0 mm	<b>Description</b>	To cover T-Slots with 6 mm width and a 3.0 mm profile web
<b>Material</b>	Kunststoff PP	<b>Material</b>	Plastic PP
<b>Farbe</b>	schwarz, natur, alufarbig	<b>Color</b>	Black, natural, alu color
<b>Liefereinheit</b>	200 Meter (100 Stück à 2 m)	<b>Pack Quantity</b>	200 meters (100 pieces at 2 m)
<b>Extras</b>	weitere Farben auf Anfrage	<b>Specials</b>	Other colors on request
<b>Hinweis</b>	Bitte beachten: Sie bestellen in Meter!	<b>Tip</b>	Please note: You are ordering in meters!

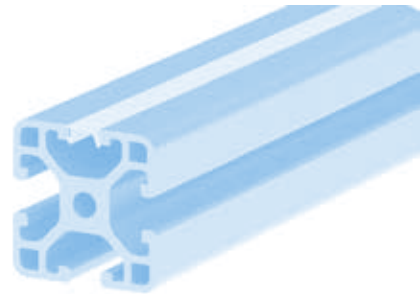
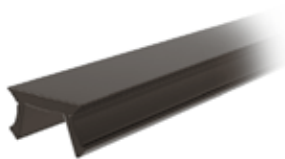
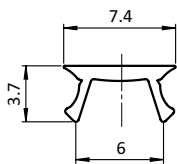

Abdeckprofil <i>Cover Profile</i>	Nut 6 <i>Slot 6</i>	Gewicht [g/m] <i>Weight [g/m]</i>	Profil <i>Profile</i>	Teil-Nr. <i>Part #</i>
schwarz <i>Black</i>	6	11.0	I	<b>092130</b>
natur <i>Natural</i>	6	11.0	I	<b>092130S01</b>
alufarbig geprägt <i>Alu color coated</i>	6	11.0	I	<b>092130A</b>

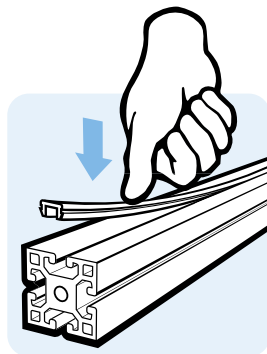



**ABDECK- UND EINFASSPROFIL**

**COVER AND REDUCTION PROFILE**

<b>Ausführung</b>	Kunststoff PP, Nut 8	<b>Model</b>	Plastic PP, slot 8
<b>Beschreibung</b>	zum Abdecken von Nuten mit Breite 8 mm und zum Einfassen von Flächenelementen mit 4 - 6 mm	<b>Description</b>	To cover size 8 profile slots and to secure panels with a thickness of 4 - 6 mm
<b>Material</b>	Kunststoff PP	<b>Material</b>	Plastic PP
<b>Farbe</b>	schwarz, natur, grau, rot, blau, gelb, weißaluminium	<b>Color</b>	Black, natural, gray, red, blue, yellow, white aluminum
<b>Liefereinheit</b>	200 Meter (100 Stück à 2 m)	<b>Pack Quantity</b>	200 meters (100 pieces at 2 m)
<b>Extras</b>	weitere Farben auf Anfrage	<b>Specials</b>	Other colors on request
<b>Hinweis</b>	Bitte beachten: Sie bestellen in Meter!	<b>Tip</b>	Please note: You are ordering in meters!

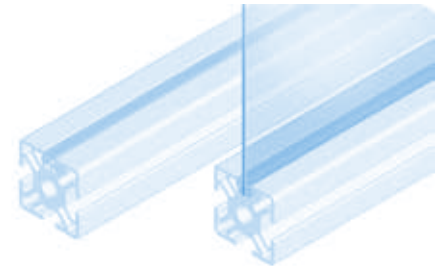
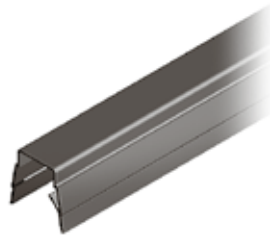
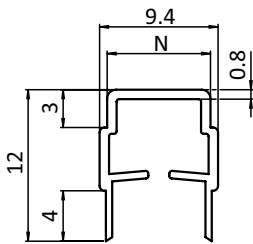

Abdeck- und Einfassprofil <i>Cover and Reduction Profile</i>	Nut Slot	Gewicht [g/m] Weight [g/m]	Profil Profile	Teil-Nr. Part #
schwarz <i>Black</i>	8	26.0	I	092031
natur <i>Natural</i>	8	26.0	I	092030
grau ≈ RAL 7035 <i>Gray</i>	8	26.0	I	092035
rot ≈ RAL 3020 <i>Red</i>	8	26.0	I	092036
blau ≈ RAL 5005 <i>Blue</i>	8	26.0	I	092037
gelb ≈ RAL 1018 <i>Yellow</i>	8	26.0	I	092031S03
weißaluminium ≈ RAL 9006 <i>White aluminum</i>	8	26.0	I	092031S04

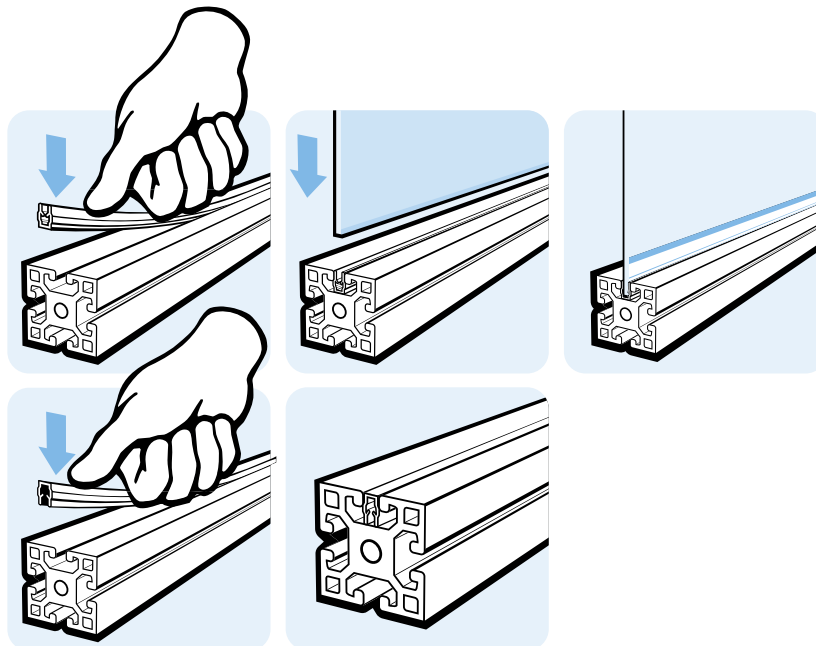



**ABDECK- UND EINFASSPROFIL**

**COVER AND REDUCTION PROFILE**

<b>Ausführung</b>	Kunststoff PP + TPE, Nut 8	<b>Model</b>	Plastic PP + TPE, slot 8
<b>Beschreibung</b>	zum Abdecken von Nuten mit Breite 8 mm und zum Einfassen von Flächenelementen mit 4 - 6 mm	<b>Description</b>	To cover size 8 profile slots and to secure panels with a thickness of 4 - 6 mm
<b>Material</b>	Kunststoff PP + TPE	<b>Material</b>	Plastic PP + TPE
<b>Farbe</b>	schwarz	<b>Color</b>	Black
<b>Liefereinheit</b>	200 Meter (100 Stück à 2 m)	<b>Pack Quantity</b>	200 meters (100 pieces at 2 m)
<b>Extras</b>	weitere Farben auf Anfrage	<b>Specials</b>	Other colors on request
<b>Hinweis</b>	Bitte beachten: Sie bestellen in Meter!	<b>Tip</b>	Please note: You are ordering in meters!

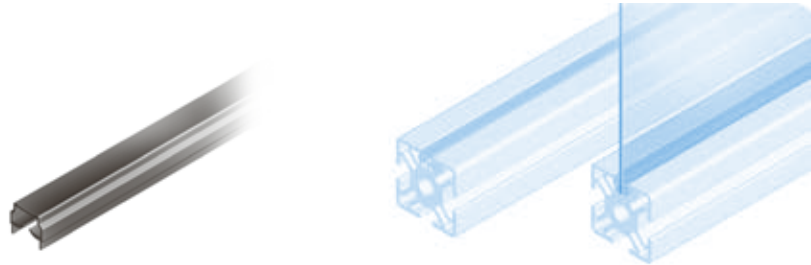
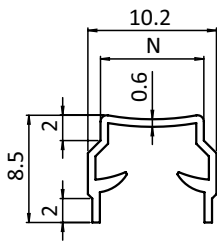

Abdeck- und Einfassprofil <i>Cover and Reduction Profile</i>	Nut Slot	Gewicht [g/m] Weight [g/m]	Profil Profile	Teil-Nr. Part #
	8	25.0	B	092242





**ABDECKPROFIL**

**COVER PROFILE**

<b>Ausführung</b>	Kunststoff PP, Nut 8, 10	<b>Model</b>	Plastic PP, slot 8, 10
<b>Beschreibung</b>	zum Abdecken von Nuten mit Breite 8 und 10 mm	<b>Description</b>	To cover size 8 and 10 profile slots
<b>Material</b>	Kunststoff PP	<b>Material</b>	Plastic PP
<b>Farbe</b>	schwarz, gelb, orange, rot, blau, grau, weiß, natur, alufarbig	<b>Color</b>	Black, yellow, orange, red, blue, gray, white, nature, alu color
<b>Liefereinheit</b>	200 Meter (100 St. à 2m)	<b>Pack Quantity</b>	200 meters (100 pieces at 2m)
<b>Extras</b>	weitere Farben auf Anfrage	<b>Specials</b>	Other colors on request
<b>Hinweis</b>	Bitte beachten: Sie bestellen in Meter!	<b>Tip</b>	Please note: You are ordering in meters!

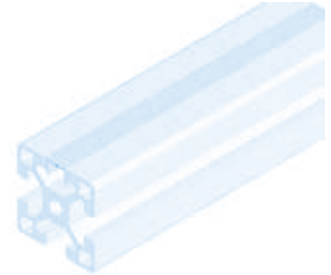
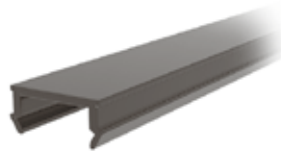
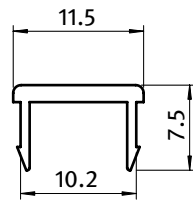
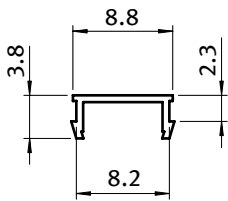

Abdeckprofil Cover Profile	Nut Slot	Gewicht [g/m] Weight [g/m]	Profil Profile	Teil-Nr. Part #
schwarz <i>Black</i>	8	10.0	B	092050
schwarz,  elektrostatisch entladend <i>Black,  electrostatically discharging</i>	8	10.0	B	092050S12
gelb ≈ RAL 1018 <i>Yellow</i>	8	10.0	B	092054
rot ≈ RAL 3020 <i>Red</i>	8	10.0	B	092050S07
blau ≈ RAL 5005 <i>Blue</i>	8	10.0	B	092050S04
grau ≈ RAL 7035 <i>Gray</i>	8	10.0	B	092052
natur <i>Natural</i>	8	10.0	B	092050S03
alufarbig geprägt <i>Alu color imprint</i>	8	10.0	B	092050A
alufarbig geprägt,  elektrostatisch entladend <i>Alu color imprint,  electrostatically discharging</i>	8	10.0	B	092050AS01
schwarz <i>Black</i>	10	28.1	B	092041
schwarz,  elektrostatisch entladend <i>Black,  electrostatically discharging</i>	10	28.1	B	092041S08
gelb ≈ RAL 1018 <i>Yellow</i>	10	28.1	B	092044
gelb ≈ RAL 1023 <i>Yellow</i>	10	28.1	B	092044S01
orange ≈ RAL 2004 <i>Orange</i>	10	28.1	B	092043
rot ≈ RAL 3020 <i>Red</i>	10	28.1	B	092041S03
blau ≈ RAL 5005 <i>Blue</i>	10	28.1	B	092041S06
grau ≈ RAL 7035 <i>Gray</i>	10	28.1	B	092042
weiß ≈ RAL 9003 <i>White</i>	10	28.1	B	092041S05
natur <i>Natural</i>	10	28.1	B	092041S13
alufarbig geprägt <i>Alu color imprint</i>	10	28.1	B	092041A
alufarbig geprägt,  elektrostatisch entladend <i>Alu color imprint,  electrostatically discharging</i>	10	28.1	B	092041AS01



**ABDECKPROFIL**

**COVER PROFILE**

<b>Ausführung</b>	Kunststoff PP, Nut 8	<b>Model</b>	Plastic PP, slot 8
<b>Beschreibung</b>	zum Abdecken von Nuten mit Breite 8 mm und Steghöhe 4,5 mm	<b>Description</b>	To cover T-Slots with 8 mm width and a 4.5 mm profile web
<b>Material</b>	Kunststoff PP	<b>Material</b>	Plastic PP
<b>Farbe</b>	schwarz, gelb, grau, natur, alufarbig	<b>Color</b>	Black, yellow, gray, natural, alu color
<b>Liefereinheit</b>	200 Meter (100 Stück à 2m)	<b>Pack Quantity</b>	200 meters (100 pieces at 2m)
<b>Extras</b>	weitere Farben auf Anfrage	<b>Specials</b>	Other colors on request
<b>Hinweis</b>	Bitte beachten: Sie bestellen in Meter!	<b>Tip</b>	Please note: You are ordering in meters!

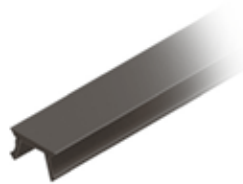
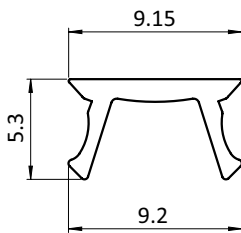

Abdeckprofil <i>Cover Profile</i>	Nut <i>Slot</i>	Gewicht [g/m] <i>Weight [g/m]</i>	Profil <i>Profile</i>	Teil-Nr. <i>Part #</i>
schwarz <i>Black</i>	8	16.0	I	092080
gelb ≈ RAL 1018 <i>Yellow</i>	8	16.0	I	092081
grau ≈ RAL 7035 <i>Gray</i>	8	16.0	I	092085
natur <i>Natural</i>	8	16.0	I	092082
alufarbig geprägt <i>Alu color imprint</i>	8	16.0	I	092080A

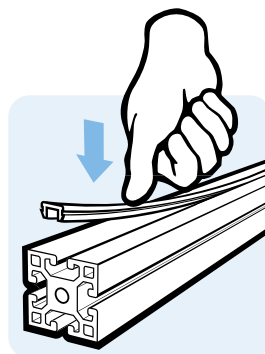



**ABDECKPROFIL**

**COVER PROFILE**

<b>Ausführung</b>	Aluminium, Nut 8	<b>Model</b>	Aluminum, slot 8
<b>Beschreibung</b>	zum Abdecken von Nuten mit Breite 8 mm und Steghöhe 4,5 mm	<b>Description</b>	To cover T-Slots with 8 mm width and a 4.5 mm profile web
<b>Material</b>	Aluminium, eloxiert	<b>Material</b>	Aluminum, anodized
<b>Liefereinheit</b>	50 Meter (25 St. à 2m)	<b>Pack Quantity</b>	50 meters (25 pieces at 2m)
<b>Hinweis</b>	Bitte beachten: Sie bestellen in Meter!	<b>Tip</b>	Please note: You are ordering in meters!

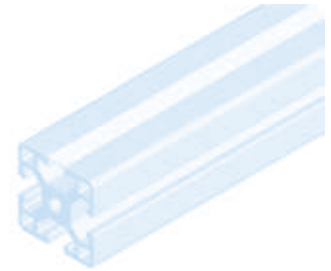
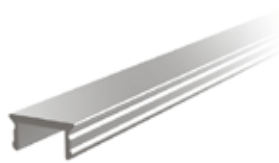
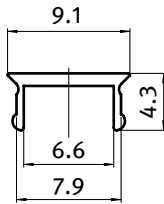

Abdeckprofil <i>Cover Profile</i>	Nut <i>Slot</i>	Gewicht [g/m] <i>Weight [g/m]</i>	Profil <i>Profile</i>	Teil-Nr. <i>Part #</i>
	8	33.0	I	092055

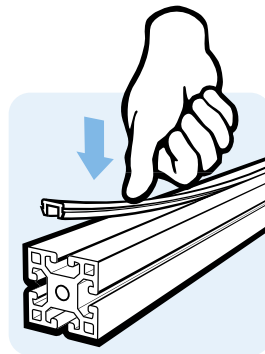



**ABDECKPROFIL**

**COVER PROFILE**

<b>Ausführung</b>	Aluminium, Nut 8	<b>Model</b>	Aluminum, slot 8
<b>Beschreibung</b>	zum Abdecken von Nuten mit Breite 8 mm und Steghöhe 4,5 mm	<b>Description</b>	To cover T-Slots with 8 mm width and a 4.5 mm profile web
<b>Material</b>	Aluminium, eloxiert	<b>Material</b>	Aluminum, anodized
<b>Liefereinheit</b>	50 Meter (25 St. à 2m)	<b>Pack Quantity</b>	50 meters (25 pieces at 2m)
<b>Hinweis</b>	Bitte beachten: Sie bestellen in Meter!	<b>Tip</b>	Please note: You are ordering in meters!

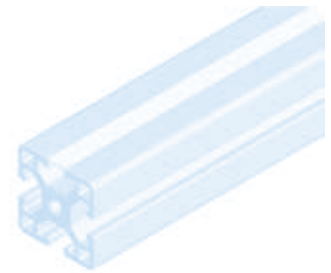
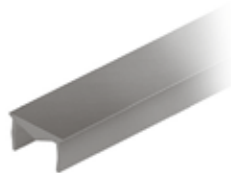
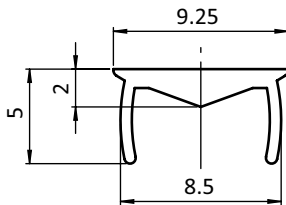

Abdeckprofil <i>Cover Profile</i>	Nut Slot	Gewicht [g/m] Weight [g/m]	Profil Profile	Teil-Nr. Part #
	8	43.0	B	092071

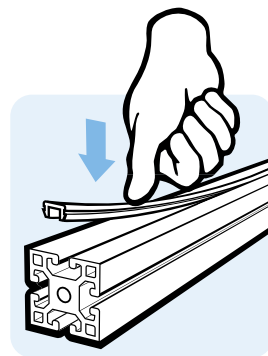



**ABDECKPROFIL**

**COVER PROFILE**

<b>Ausführung</b>	Aluminium, Nut 10	<b>Model</b>	Aluminum, slot 10
<b>Beschreibung</b>	zum Abdecken von Nuten mit Breite 10 mm und Steghöhe 6 mm	<b>Description</b>	To cover T-Slots with 10 mm width and a 6 mm profile web
<b>Material</b>	Aluminium, eloxiert	<b>Material</b>	Aluminum, anodized
<b>Liefereinheit</b>	50 Meter (25 St. à 2m)	<b>Pack Quantity</b>	50 meters (25 pieces at 2m)
<b>Hinweis</b>	Bitte beachten: Sie bestellen in Meter!	<b>Tip</b>	Please note: You are ordering in meters!

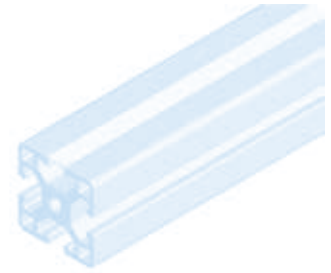
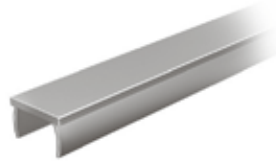
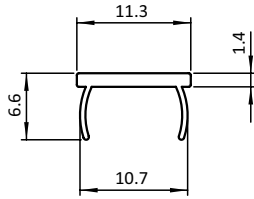

Abdeckprofil <i>Cover Profile</i>	Nut <i>Slot</i>	Gewicht [g/m] <i>Weight [g/m]</i>	Profil <i>Profile</i>	Teil-Nr. <i>Part #</i>
	10	56.5	B	092070

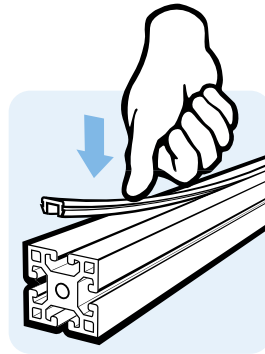



**ABDECKPROFIL**

**COVER PROFILE**

<b>Ausführung</b>	Kunststoff NBR, Nut 6, Nut 8	<b>Model</b>	Plastic NBR, slot 6, slot 8
<b>Beschreibung</b>	zum Abdecken von Aluprofilen	<b>Description</b>	To cover aluminum profiles
<b>Material</b>	Kunststoff NBR, ≈80 Shore A	<b>Material</b>	Plastic NBR, ≈80 Shore A
<b>Farbe</b>	schwarz	<b>Color</b>	Black
<b>Liefereinheit</b>	20 Meter (Spule)	<b>Pack Quantity</b>	20 meter (spool)
<b>Hinweis</b>	Bitte beachten: Sie bestellen in Meter!	<b>Tip</b>	Please note: You are ordering in meters!

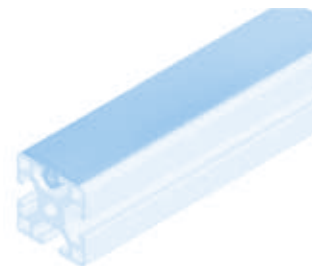
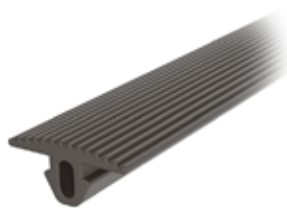
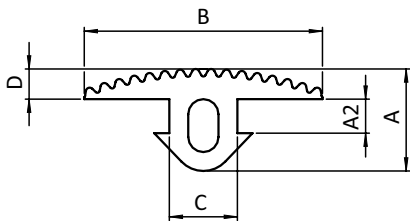

Abdeckprofil <i>Cover Profile</i>	A [mm]	A2 (Profil) [mm] A2 (Profile) [mm]	B [mm]	C [mm]	D [mm]	Nut Slot	Gewicht [g/m] Weight [g/m]	Profil Profile	Teil-Nr. Part #
	11.0	2.5 (3.0)	26.0	6.5	3.0	6	103.0	I	<b>092058</b>
	13.5	4.5 (4.5)	31.5	9	4.0	8	210.0	I	<b>092057</b>

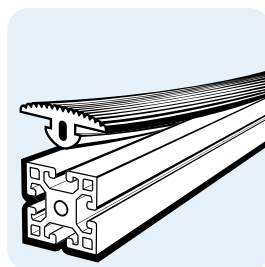

**ABDECKKAPPE FÜR RASTERMAß 20 MM**

**COVER CAP FOR 20 MM MODULAR DIMENSION**

<b>Ausführung</b>	Rastermaß 20 mm	<b>Model</b>	20 mm modular dimension
<b>Beschreibung</b>	zum Abdecken der Profilenden	<b>Description</b>	To cover the end of the profile
<b>Material</b>	Kunststoff PA, glasfaserverstärkt	<b>Material</b>	Plastic PA, glass fiber reinforced
<b>Farbe</b>	schwarz	<b>Color</b>	Black
<b>Liefereinheit</b>	100 Stück	<b>Pack Quantity</b>	100 pieces
<b>Extras</b>	☁ elektrostatisch entladend, weitere Größen, weitere Farben auf Anfrage	<b>Specials</b>	☁ electrostatically discharging, other sizes, other colors on request

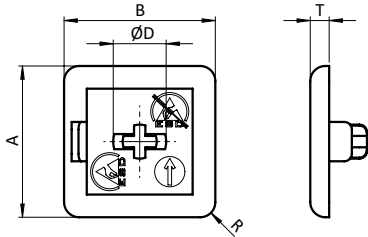

Abdeckkappe Cover Cap	ØD [mm]	R [mm]	T [mm]	Eigenschaft Description	Maße A x B [mm] Dimensions A x B [mm]	Profil Profile	Teil-Nr. Part #
Nut 5 <i>Slot 5</i>	3.4 (3.3)	2.0	3.0	2 Kreuze <i>2 cross</i>	10 x 20	I	<b>091125</b>
	3.4 (3.3)	2.0	2.5	2 Stifte <i>2 pins</i>	10 x 40	I	<b>091236</b>
	4.5 (4.3)	2.5	4.0	1 Kreuz <i>1 cross</i>	20 x 20	I	<b>091043</b>
	4.5 (4.3)	2.0	2.5	neue Ausführung, 1 Stift <i>New version, 1 pin</i>	20 x 20	I	<b>091180</b>
	4.5 (4.3)	2.5	4.0	1 Kreuz <i>1 cross</i>	20 x 40	I	<b>091050</b>
	4.5 (4.3)	2.0	2.5	neue Ausführung, 2 Kreuze <i>New version, 2 cross</i>	20 x 40	I	<b>091181</b>
	4.5 (4.3)	2.0	2.5	3 Kreuze <i>3 cross</i>	20 x 60	I	<b>091183</b>
	4.5 (4.3)	2.0	2.5	4 Kreuze <i>4 cross</i>	40 x 40	I	<b>091182</b>
Nut 6 <i>Slot 6</i>	5.4 (5.5)	2.5	4.0	1 Kreuz <i>1 cross</i>	20 x 20	B	<b>091042</b>
	5.7 (5.5)	1.5	2.5	neue Ausführung, 1 Kreuz <i>New version, 1 cross</i>	20 x 20	B	<b>091332</b>

**ABDECKKAPPE FÜR RASTERMAß 30 MM**

**COVER CAP FOR 30 MM MODULAR DIMENSION**

<b>Ausführung</b>	Rastermaß 30 mm	<b>Model</b>	30 mm modular dimension
<b>Beschreibung</b>	zum Abdecken der Profilen	<b>Description</b>	To cover the end of the profile
<b>Material</b>	Kunststoff PA, glasfaserverstärkt	<b>Material</b>	Plastic PA, glass fiber reinforced
<b>Farbe</b>	schwarz	<b>Color</b>	Black
<b>Liefereinheit</b>	100 Stück	<b>Pack Quantity</b>	100 pieces
<b>Extras</b>	☁ elektrostatisch entladend, weitere Größen, weitere Farben auf Anfrage	<b>Specials</b>	☁ electrostatically discharging, other sizes, other colors on request

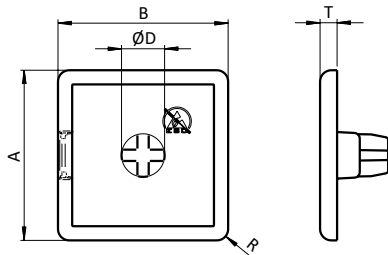

Abdeckkappe <i>Cover Cap</i>	ØD [mm]	R [mm]	T [mm]	Eigenschaft <i>Description</i>	Maße A x B [mm] <i>Dimensions A x B [mm]</i>	Profil <i>Profile</i>	Teil-Nr. <i>Part #</i>
Nut 6 <i>Slot 6</i>	5.2 (5.0)	3.0	3.0	4 Kreuze 4 cross	30 x 120	I	091187
	5.2 (5.0)	3.0	3.0	1 Kreuz 1 cross	30 x 30	I	091184
	5.2 (5.0)	3.0	3.0	1 Kreuz 1 cross	30 x 30 45°	I	091188
	5.2 (5.0)	3.0	3.0	1 Kreuz 1 cross	30 x 30 R30 - 90°	I	091245
	6.9 (7.3)	3.0	4.0	2 Kreuze 2 cross	30 x 60	I	091141
	5.2 (5.0)	3.0	3.0	neue Ausführung, 2 Kreuze <i>New version, 2 cross</i>	30 x 60	I	091185
	5.2 (5.0)	3.0	3.0	4 Kreuze 4 cross	60 x 60	I	091186
Nut 8 <i>Slot 8</i>	3.3	2.0	3.0	3 Stifte 3 pins	11 x 20	B	091346
	7.6 (7.3)	3.0	4.0	1 Kreuz 1 cross	30 x 30	B	091027
	10.8 (10.0)	3.0	4.0	neue Ausführung 1, 1 Kreuz gedreht 45° <i>New version 1, 1 cross turned 45°</i>	30 x 30	B	091252
	7.6 (7.3)	2.0	3.0	neue Ausführung 2, 1 Kreuz <i>New version 2, 1 cross</i>	30 x 30	B	091371
	4.0	2.0	3.0	mit Loch Ø 8.5 mm, 4 Stifte <i>With hole Ø 8.5 mm, 4 pins</i>	30 x 30	B	091359
	10.8 (10.0)	2.0	3.0	1 Kreuz 1 cross	30 x 30 R25 - 90°	B	091344
	7.6 (7.3)	3.0	4.0	2 Kreuze 2 cross	30 x 60	B	091179
Nut 8 / 10 <i>Slot 8 / 10</i>	8.4 (7.3)	2.0	3.0	4 Stifte 4 pins	30 x 45	B	091370
	8.4 (7.3)	2.0	3.0	☁ elektrostatisch entladend, 4 Stifte ☁ electrostatically discharging, 4 pins	30 x 45	B	091370S01



**ABDECKKAPPE FÜR RASTERMAß 40 MM**

**COVER CAP FOR 40 MM MODULAR DIMENSION**

<b>Ausführung</b>	Rastermaß 40 mm	<b>Model</b>	40 mm modular dimension
<b>Beschreibung</b>	zum Abdecken der Profilenden	<b>Description</b>	To cover the end of the profile
<b>Material</b>	Kunststoff PA, glasfaserverstärkt	<b>Material</b>	Plastic PA, glass fiber reinforced
<b>Farbe</b>	schwarz	<b>Color</b>	Black
<b>Liefereinheit</b>	100 Stück	<b>Pack Quantity</b>	100 pieces
<b>Extras</b>	☁ elektrostatisch entladend, weitere Größen, weitere Farben auf Anfrage	<b>Specials</b>	☁ electrostatically discharging, other sizes, other colors on request

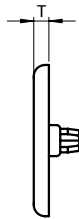
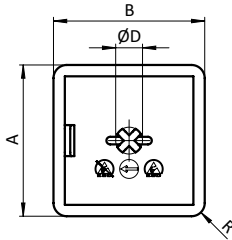

Abdeckkappe Cover Cap	ØD [mm]	R [mm]	T [mm]	Eigenschaft Description	Maße [mm] Dimensions [mm]	Profil Profile	Teil-Nr. Part #
Nut 8 Slot 8	5.1 (5.0)	3.5	4.0	2 Stifte 2 pins	16 x 40	I	091077
	4.4 (4.3)	3.5	4.0	2 Stifte 2 pins	16 x 80	I	091078
	4.3 (4.0)	3.5	4.0	6 Stifte 6 pins	16 x 160	I	091278
	7.1 (6.8)	3.5	4.0	1 Kreuz 1 cross	40 x 40	I	091007
	7.0 (6.8)	4.0	4.0	1 Kreuz 1 cross	40 x 40 45°	I	091048
	7.2 (6.8)	2.5	4.0	1 Kreuz 1 cross	40 x 40 R40 - 90°	I	091045
	6.8 (6.8)	4.0	4.0	neue Ausführung, 1 Kreuz New version, 1 cross	40 x 40 R40 - 90°	I	091320
	6.9 (6.8)	4.0	4.0	2 Kreuze 2 cross	40 x 80	I	091009
	6.9 (6.8)	3.0	4.0	1 Kreuz und 2 Stifte 1 cross and 2 pins	40 x 120	I	091094
	6.9 (6.8)	3.5	4.0	2 Kreuze und 2 Stifte 2 cross and 2 pins	40 x 160	I	091209
	6.8 (6.8)	4.0	4.0	4 Kreuze 4 cross	80 x 80	I	091023
	6.9 (6.8)	3.5	4.0	4 Kreuze 4 cross	80 x 120	I	091095
	6.8 (6.8)	4.0	4.0	8 Stifte 8 pins	80 x 160	I	091118
Nut 10 Slot 10	10.2 (10.0)	3.0	4.0	1 Kreuz 1 cross	40 x 40	B	091046
	10.4 (10.0)	3.0	4.0	☁ elektrostatisch entladend, 1 Kernloch-Zapfen ☁ electrostatically discharging, 1 Pin for core hole	40 x 40 R30 - 90°	B	091345S01
	10.1 (10.0)	3.0	4.0	2 Kreuze 2 cross	40 x 80	B	091137
	10.4 (10.0)	3.0	4.0	4 Kreuze 4 cross	80 x 80	B	091135

**ABDECKKAPPE FÜR RASTERMAß 45 MM**

**COVER CAP FOR 45 MM MODULAR DIMENSION**

<b>Ausführung</b>	Rastermaß 45 mm	<b>Model</b>	45 mm modular dimension
<b>Beschreibung</b>	zum Abdecken der Profilenenden	<b>Description</b>	To cover the end of the profile
<b>Material</b>	Kunststoff PA, glasfaserverstärkt	<b>Material</b>	Plastic PA, glass fiber reinforced
<b>Farbe</b>	schwarz	<b>Color</b>	Black
<b>Liefereinheit</b>	100 Stück	<b>Pack Quantity</b>	100 pieces
<b>Extras</b>	☁ elektrostatisch entladend, weitere Größen, weitere Farben auf Anfrage	<b>Specials</b>	☁ electrostatically discharging, other sizes, other colors on request

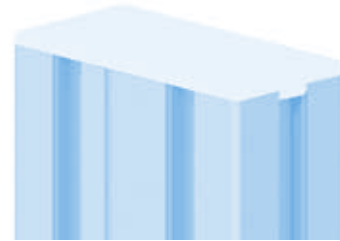
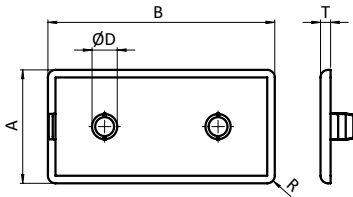

Abdeckkappe <i>Cover Cap</i>	ØD [mm]	R [mm]	T [mm]	Eigenschaft <i>Description</i>	Maße [mm] <i>Dimensions [mm]</i>	Profil <i>Profile</i>	Teil-Nr. <i>Part #</i>
Nut 10 <i>Slot 10</i>	4.0	3.0	4.0	4 Stifte 4 pins	22.5 x 45	B	091002
	10.4 (10.0)	4.0	4.0	1 Kernloch-Zapfen 1 Pin for core hole	45 x 45	B	091011
	4.0	3.0	4.0	mit Loch Ø 17.0 mm, 4 Stifte 4.3 <i>With hole Ø 17.0 mm, 4 pins 4.3</i>	45 x 45	B	091015
	10.8 (10.0)	3.0	4.0	1 Kernloch-Zapfen 1 Pin for core hole	45 x 60	B	091017
	(4.0)	3.0	4.0	mit Loch Ø 18.3 mm, 4 Stifte 4.3 <i>With hole Ø 18.3 mm, 4 pins 4.3</i>	45 x 60	B	091083
	10.4 (10.0)	3.0	4.0	2 Kernloch-Zapfen 2 Pins for core hole	45 x 90	B	091006
	-	3.5	4.0	4 Stützrippen 4 support ribs	90 x 90	B	091024
	15.1	3.0	4.0	neue Ausführung, 4 Stützrippen <i>New version, 4 support ribs</i>	90 x 90	B	091207
	10.2 (10.0)	5.0	4.0	4 Kernloch-Zapfen, 4 Stifte <i>4 Pins for core hole, 4 pins</i>	90 x 90 leicht (superleicht) <i>90 x 90 light (superlight)</i>	B	091030
	15.2	3.0	4.0	8 Stützrippen 8 support ribs	90 x 90 leicht (superleicht) <i>90 x 90 light (superlight)</i>	B	091276

**ABDECKKAPPE FÜR KLEMMPROFIL**

**COVER CAP FOR CLAMP PROFILE**

<b>Ausführung</b>	Rastermaß 50 mm	<b>Model</b>	50 mm modular dimension
<b>Beschreibung</b>	zum Abdecken der Profilenden	<b>Description</b>	To cover the end of the profile
<b>Material</b>	Kunststoff PA, glasfaserverstärkt	<b>Material</b>	Plastic PA, glass fiber reinforced
<b>Farbe</b>	schwarz	<b>Color</b>	Black
<b>Liefereinheit</b>	100 Stück	<b>Pack Quantity</b>	100 pieces
<b>Extras</b>	☁ elektrostatisch entladend, weitere Größen, weitere Farben auf Anfrage	<b>Specials</b>	☁ electrostatically discharging, other sizes, other colors on request

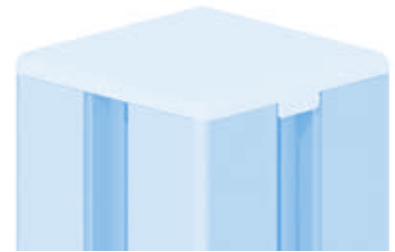
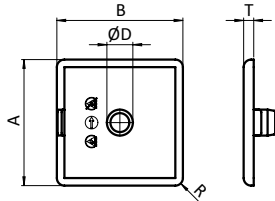

Abdeckkappe für Klemmprofil <i>Cover Cap for Clamp Profile</i>	ØD [mm]	R [mm]	T [mm]	Eigenschaft <i>Description</i>	Maße [mm] <i>Dimensions [mm]</i>	Profil <i>Profile</i>	Teil-Nr. <i>Part #</i>
Nut 10 <i>Slot 10</i>	10.3 (10.0)	3.0	4.0	1 Kernloch-Zapfen <i>1 Pin for core hole</i>	50 x 50	B	<b>091028</b>

**ABDECKKAPPE FÜR RASTERMAß 60 MM**

**COVER CAP FOR 60 MM MODULAR DIMENSION**

<b>Ausführung</b>	Rastermaß 60 mm	<b>Model</b>	60 mm modular dimension
<b>Beschreibung</b>	zum Abdecken der Profilenenden	<b>Description</b>	To cover the end of the profile
<b>Material</b>	Kunststoff PA, glasfaserverstärkt	<b>Material</b>	Plastic PA, glass fiber reinforced
<b>Farbe</b>	schwarz	<b>Color</b>	Black
<b>Liefereinheit</b>	100 Stück	<b>Pack Quantity</b>	100 pieces
<b>Extras</b>	☁ elektrostatisch entladend, weitere Größen, weitere Farben auf Anfrage	<b>Specials</b>	☁ electrostatically discharging, other sizes, other colors on request

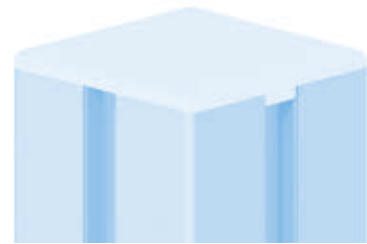
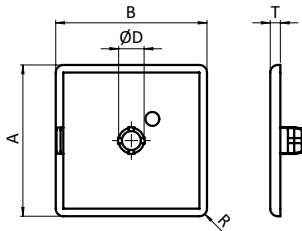

Abdeckkappe <i>Cover Cap</i>	ØD [mm]	R [mm]	T [mm]	Eigenschaft <i>Description</i>	Maße [mm] <i>Dimensions [mm]</i>	Profil <i>Profile</i>	Teil-Nr. <i>Part #</i>
Nut 10 <i>Slot 10</i>	10.6 (10.0)	3.0	4.0	1 Kernloch-Zapfen <i>1 Pin for core hole</i>	60 x 60	B	<b>091021</b>

**ABDECKKAPPE FÜR KLEMMPROFIL**

**COVER CAP FOR CLAMP PROFILE**

<b>Ausführung</b>	für Klemmprofil	<b>Model</b>	For clamp profile
<b>Beschreibung</b>	zum Abdecken der Profilenenden	<b>Description</b>	To cover the end of the profile
<b>Material</b>	Kunststoff PA, glasfaserverstärkt	<b>Material</b>	Plastic PA, glass fiber reinforced
<b>Farbe</b>	schwarz	<b>Color</b>	Black
<b>Liefereinheit</b>	100 Stück	<b>Pack Quantity</b>	100 pieces
<b>Extras</b>	☁ elektrostatisch entladend, weitere Größen, weitere Farben auf Anfrage	<b>Specials</b>	☁ electrostatically discharging, other sizes, other colors on request

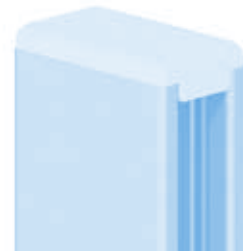
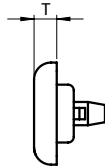
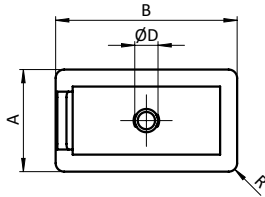

Abdeckkappe für Klemmprofil <i>Cover Cap for Clamp Profile</i>	ØD [mm]	R [mm]	T [mm]	Eigenschaft <i>Description</i>	Maße [mm] <i>Dimensions [mm]</i>	Profil <i>Profile</i>	Teil-Nr. <i>Part #</i>
Nut 10 Slot 10	4.3	1.5	4.0	1 Stift 1 pin	18 x 32	I	091049

**ABDECKKAPPEN FÜR SCHUTZGITTERPROFILE**

**COVER CAPS FOR WIRE MESH FRAME PROFILES**

<b>Ausführung</b>	Kunststoff PA	<b>Model</b>	Plastic PA
<b>Beschreibung</b>	zum Abdecken der Profilenenden von Schutzgitterprofilen	<b>Description</b>	To seal the end openings of conduit systems
<b>Material</b>	Kunststoff PA, glasfaserverstärkt	<b>Material</b>	Plastic PA, glass fiber reinforced
<b>Farbe</b>	schwarz	<b>Color</b>	Black
<b>Liefereinheit</b>	100 Stück	<b>Pack Quantity</b>	100 pieces
<b>Extras</b>	☁elektrostatisch entladend, weitere Größen, weitere Farben auf Anfrage	<b>Specials</b>	☁electrostatically discharging, other sizes, other colors on request

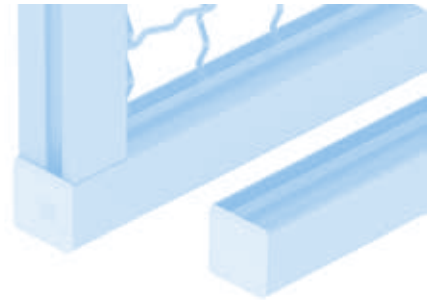
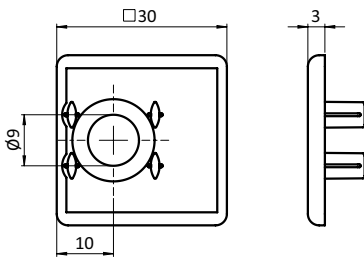

Abdeckkappen für Schutzgitterprofile <i>Cover Caps for Wire Mesh Frame Profiles</i>	ØD [mm]	R [mm]	T [mm]	Eigenschaft <i>Description</i>	Gewicht [g] <i>Weight [g]</i>	Profil <i>Profile</i>	Teil-Nr. <i>Part #</i>
mit Loch <i>With hole</i>		2.0	3.0	4 Stifte <i>4 pins</i>	3.4	B	<b>091337</b>
ohne Loch <i>Without hole</i>		2.0	3.0	4 Stifte <i>4 pins</i>	3.0	B	<b>091337S01</b>

**ABDECKKAPPEN ANSCHRAUBBAR**

**COVER CAPS, SCREW-ON TYPE**

<b>Ausführung</b>	Kunststoff PA	<b>Model</b>	Plastic PA
<b>Beschreibung</b>	anschraubbare Abdeckung für Profilen	<b>Description</b>	Bolt-on cover cap for the end of the aluminum profile
<b>Material</b>	Kunststoff PA, glasfaserverstärkt	<b>Material</b>	Plastic PA, glass fiber reinforced
<b>Farbe</b>	schwarz	<b>Color</b>	Black
<b>Befestigung</b>	* mit Senkkopfschrauben M4 x 16, Stahl verzinkt	<b>Fastening</b>	* With flat socket cap screws M4 x 16, zinc plated steel
<b>Liefereinheiten</b>	10 / 50 / 100 Stück	<b>Pack Quantities</b>	10 / 50 / 100 pieces
<b>Extras</b>	☁ elektrostatisch entladend, weitere Größen, weitere Farben auf Anfrage	<b>Specials</b>	☁ electrostatically discharging, other sizes, other colors on request
<b>Hinweis</b>	* Bitte separat bestellen: Senkkopfschrauben sind nicht im Lieferumfang der Abdeckkappen enthalten.	<b>Tip</b>	* Please order separately; flat socket cap screws are not included in delivery of the cover caps.

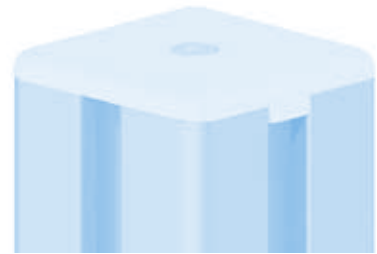
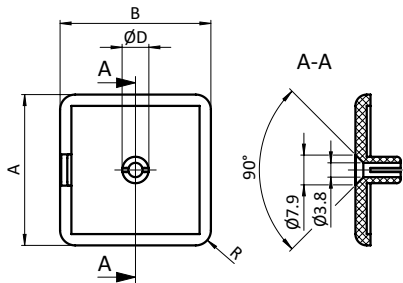

Abdeckkappe Cover Cap	D [mm]	R [mm]	T [mm]	Eigenschaft Description	Liefereinheit Pack Quantity	Gewicht [g] Weight [g]	Schraube Screw	Teil-Nr. Part #
30 x 30	7.0	3.0	4.0	1 Kernloch-Zapfen 1Pin for core hole	100	3.5	1 Schraube 1 screw	<a href="#">091065</a>
30 x 60	7.0	3.0	4.0	2 Kernloch-Zapfen 2 Pins for core hole	100	7.6	2 Schrauben 2 screws	<a href="#">091066</a>
40 x 40	7.0	4.0	4.0	1 Kernloch-Zapfen 1Pin for core hole	100	6.8	1 Schraube 1 screw	<a href="#">091067</a>
40 x 80	7.0	4.0	4.0	2 Kernloch-Zapfen 2 Pins for core hole	50	13.0	2 Schrauben 2 screws	<a href="#">091068</a>
45 x 45	10.5	3.0	4.0	1 Kernloch-Zapfen 1Pin for core hole	100	8.8	1 Schraube 1 screw	<a href="#">091070</a>
45 x 60	10.4	3.0	4.0	1 Kernloch-Zapfen 1Pin for core hole	100	10.3	1 Schraube 1 screw	<a href="#">091072</a>
45 x 90	10.4	3.0	4.0	2 Kernloch-Zapfen 2 Pins for core hole	10	15.0	2 Schrauben 2 screws	<a href="#">091073</a>
60 x 60	10.5	3.0	4.0	1 Kernloch-Zapfen 1Pin for core hole	50	15.0	1 Schraube 1 screw	<a href="#">091071</a>
80 x 80	7.0	4.0	4.0	4 Kernloch-Zapfen 4 Pins for core hole	10	27.4	4 Schrauben 4 screws	<a href="#">091069</a>
90 x 90	10.4	3.0	4.0	4 Kernloch-Zapfen 4 Pins for core hole	10	34.4	4 Schrauben 4 screws	<a href="#">091074</a>
Senkkopfschraube Flat socket cap screw				M4 x 16	100	1.0	*4DIN7991M0416M	

**ABDECKKAPPEN ZN ANSCHRAUBBAR**

**COVER CAPS ZN SCREW-ON TYPE**

<b>Ausführung</b>	Zinkdruckguss	<b>Model</b>	Zinc die-cast
<b>Beschreibung</b>	anschraubbare Abdeckung für Profilen	<b>Description</b>	Bolt-on cover cap for the end of the aluminum profiles
<b>Material</b>	Zinkdruckguss	<b>Material</b>	Zinc die-cast
<b>Farbe</b>	schwarz	<b>Color</b>	Black
<b>Befestigung</b>	mit selbstformenden Senkkopfschrauben S7 x 16*	<b>Fastening</b>	With self forming countersunk screws S7 x 16*
<b>Liefereinheit</b>	10 Stück	<b>Pack Quantity</b>	10 pieces
<b>Extras</b>	weitere Größen, weitere Farben auf Anfrage	<b>Specials</b>	Other sizes, other colors on request
<b>Hinweis</b>	* passende selbstformende Senkkopfschraube S7 x 16 siehe Seite 417	<b>Tip</b>	* Compatible self forming countersunk screw see page 417

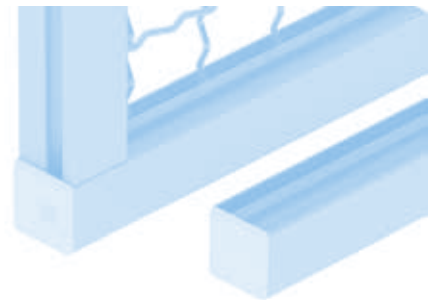
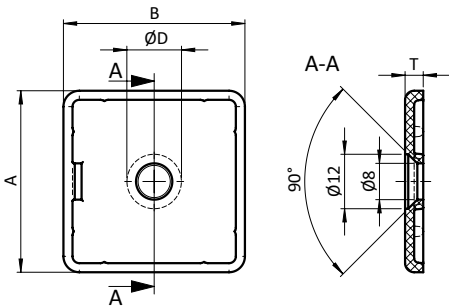

Abdeckkappe Cover Cap	ØD [mm]	R [mm]	T [mm]	Eigenschaft Description	Maße Dimensions	Gewicht [g] Weight [g]	Profil Profile	Teil-Nr. Part #
Nut 8 Slot 8	8.0 (6.8)	3.5	4.0	Bohrung für Senkschraube Bore for countersunk screw	40 x 40	25.5	I	091347
	8.0 (6.8)	3.5	4.0	Bohrung für Senkschraube Bore for countersunk screw	40 x 80	50.0	I	091348
	8.0 (6.8)	3.5	4.0	Bohrung für Senkschraube Bore for countersunk screw	80 x 80	98.0	I	091349



**KANAL-ABDECKKAPPEN**

**CONDUIT CAPS**

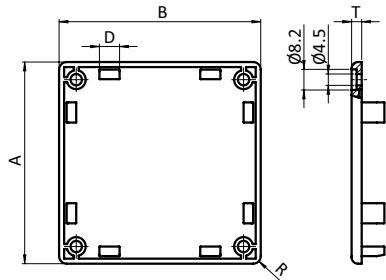

<b>Ausführung</b>	Kunststoff PA	<b>Model</b>	Plastic PA
<b>Beschreibung</b>	zur stirnseitigen Abdeckung von Kanälen; Befestigung mit Schraube M 4	<b>Description</b>	To seal the end openings of conduit systems; Fastening with screw M 4
<b>Material</b>	Kunststoff PA, glasfaserverstärkt	<b>Material</b>	Plastic PA, glass fiber reinforced
<b>Farbe</b>	schwarz	<b>Color</b>	Black
<b>Liefereinheiten</b>	10 / 50 / 100 Stück	<b>Pack Quantities</b>	10 / 50 / 100 pieces
<b>Extras</b>	☁ elektrostatisch entladend, weitere Größen, weitere Farben auf Anfrage	<b>Specials</b>	☁ electrostatically discharging, other sizes, other colors on request



Abdeckkappe Cover Cap	R [mm]	T [mm]	Eigenschaft Description	Größe Size	Liefereinheit Pack Quantity	Gewicht [g] Weight [g]	Profil Profile	Teil-Nr. Part #
4 Bohrungen 4 bore holes	4.0	4.0	4 Stützrippen 4 support ribs	40 x 40	100	8.4	I	<b>091168</b>
	3.0	4.0	6 Stützrippen 6 support ribs	40 x 80	50	14.0	I	<b>091194</b>
	3.0	4.0	8 Stützrippen 8 support ribs	40 x 120	10	21.8	I	<b>091201</b>
	4.0	4.0	10 Stützrippen 10 support ribs	40 x 160	10	29.0	I	<b>091204</b>
	3.0	4.0	8 Stützrippen 8 support ribs	80 x 80	10	28.4	I	<b>091195</b>
45° links; 3 Bohrungen 45° left; 3 bore holes	4.0	4.0	4 Stützrippen 4 support ribs	80 x 80	10	27.0	I	<b>091248L</b>
45° rechts; 3 Bohrungen 45° right; 3 bore holes	4.0	4.0	4 Stützrippen 4 support ribs	80 x 80	10	27.0	I	<b>091248R</b>
4 Bohrungen 4 bore holes	3.0	4.0	10 Stützrippen 10 support ribs	80 x 120	10	46.6	I	<b>091202</b>
	3.0	4.0	12 Stützrippen 12 support ribs	80 x 160	10	59.0	I	<b>091203</b>
20° links; 4 Bohrungen 20° left; 4 bore holes	4.0	4.0	9 Stützrippen 9 support ribs	80 x 160	10	59.0	I	<b>091249L</b>
20° rechts; 4 Bohrungen 20° right; 4 bore holes	4.0	4.0	9 Stützrippen 9 support ribs	80 x 160	10	59.0	I	<b>091249R</b>
4 Bohrungen 4 bore holes	3.0	4.0	12 Stützrippen 12 support ribs	120 x 120	10	72.8	I	<b>091246</b>
	3.0	4.0	14 Stützrippen 14 support ribs	120 x 160	10	93.0	I	<b>091247</b>

**ABDECKKAPPE FÜR EINHÄNGEPROFIL**

**COVER CAP FOR SUSPENSION PROFILE**

<b>Ausführung</b>	Kunststoff PA	<b>Model</b>	Plastic PA
<b>Beschreibung</b>	zum Abdecken der Profilenenden von Einhängprofilen	<b>Description</b>	To seal the end openings of suspension profiles
<b>Material</b>	Kunststoff PA, kohlefaserverstärkt	<b>Material</b>	Plastic PA, carbon fiber reinforced
<b>Farbe</b>	schwarz	<b>Color</b>	Black
<b>Liefereinheit</b>	20 Stück	<b>Pack Quantity</b>	20 pieces
<b>Extras</b>	nicht  elektrostatisch entladende Ausführung auf Anfrage	<b>Specials</b>	not  electrostatically discharging version on request

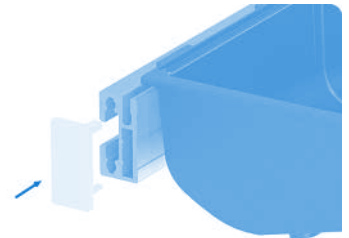
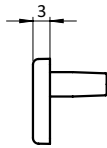
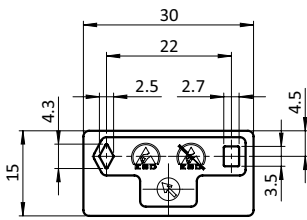

Abdeckkappe für Einhängprofil  
 Cover Cap for Suspension Profile

Gewicht [g]  
 Weight [g]

Profil  
 Profile

Teil-Nr.  
 Part #

elektrostatisch entladend  electrostatically discharging	1.6	B	<b>091374S01</b>
---	-----	---	------------------

**ABDECKKAPPEN**

**COVER CAPS**

<b>Ausführung</b>	Kunststoff PA	<b>Model</b>	Plastic PA
<b>Beschreibung</b>	zum Abdecken der Profilenden, passend für Aluminiumabdeckprofilstücke	<b>Description</b>	To cover the end of the profile, suitable for pieces of aluminum cover profiles
<b>Material</b>	Kunststoff PA, glasfaserverstärkt	<b>Material</b>	Plastic PA, glass fiber reinforced
<b>Farbe</b>	schwarz	<b>Color</b>	Black
<b>Liefereinheit</b>	100 Stück	<b>Pack Quantity</b>	100 pieces
<b>Extras</b>	☁ elektrostatisch entladend, weitere Größen, weitere Farben auf Anfrage	<b>Specials</b>	☁ electrostatically discharging, other sizes, other colors on request

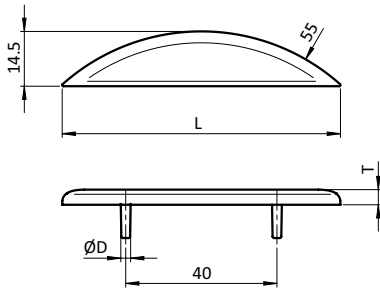

Abdeckkappe Cover Cap	L [mm]	Maße [mm] Dimensions [mm]	Gewicht [g] Weight [g]	Profil Profile	Teil-Nr. Part #
	74	R80	2.0	I	091333



**CLIP 8**

**CLIP 8**

<b>Ausführung</b>	Nut 8	<b>Model</b>	Slot 8
<b>Beschreibung</b>	zur Befestigung von Aluminiumabdeckprofilstücken auf Aluminiumprofil Nut 8; empfohlene Anzahl: 5 Stück auf 1 m	<b>Description</b>	To fix pieces of aluminum cover profiles to aluminum profiles, slot 8; recommended quantity: 5 pcs. per 1 m
<b>Material</b>	Federstahl	<b>Material</b>	Spring steel
<b>Liefereinheit</b>	10 Stück	<b>Pack Quantity</b>	10 pieces

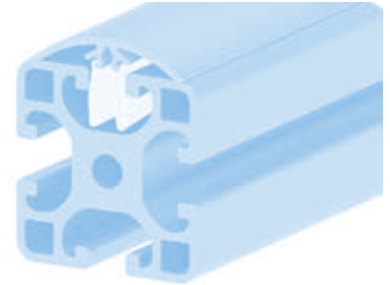
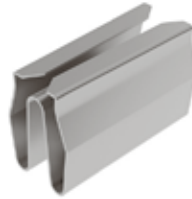
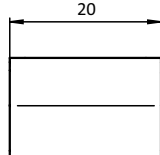
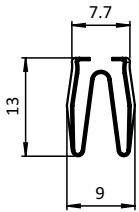

Clip 8	Gewicht [g] Weight [g]	Profil Profile	Teil-Nr. Part #
	2.6	I	092311N08